

MODEL	REV	CHANGE LIST	Model	ZP1 TOUCHPAD BOARD	
			Page	FM	TO
ZP1 TP BOARD	1A	First Release	1	3A	3B
	2A	Reference ECN E200305-1522			
	2B	Reference ECN E200306-1596			
	3A	Reference ECN E200307-0524			
	3B	Reference ECN E200308-0602			
		PROJECT : ZP1	PCBA NO.32ZP1TP0007	REV: 3B	DOC. NO: 204
		APPROVED BY : Jason Liu	CHECK BY: Jason Liu	DRAWING BY: Kent Chen	DATE :08/06/2003
					SHEET 1

# ZP1 TouchPAD board

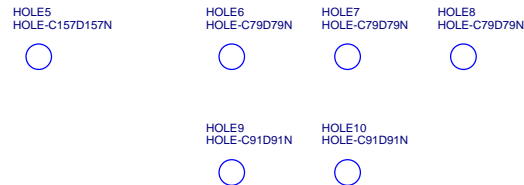
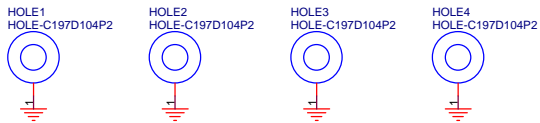
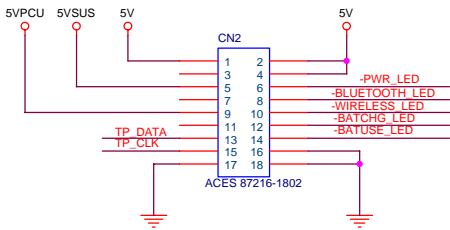
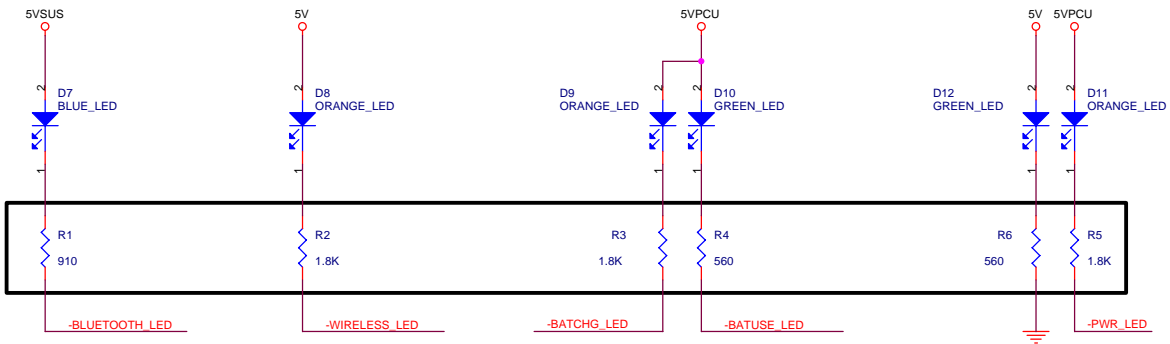
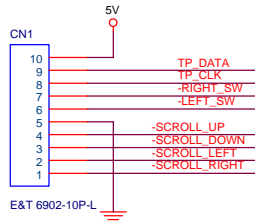
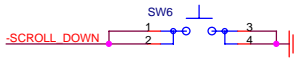
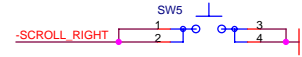
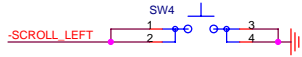
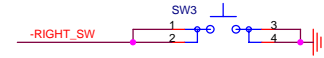
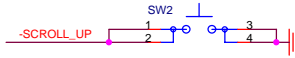
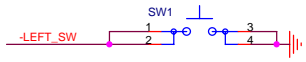

**PROJECT : ZP1**  
**Quanta Computer Inc.**

Size	Document Number	Rev
Custom	ZP1 TouchPAD board	3B
Date:	Wednesday, September 17, 2003	Sheet 1 of 1

[www.s-manuals.com](http://www.s-manuals.com)